

Aluminum Ladder/Ventilated Tray

Horizontal TEE (6"H)

HORIZONTAL TEE (ALUMINUM)

Manufactured in Canada by Niedax CER

Note: Couplings C/W Hardware are supplied with each fitting.

END VIEW

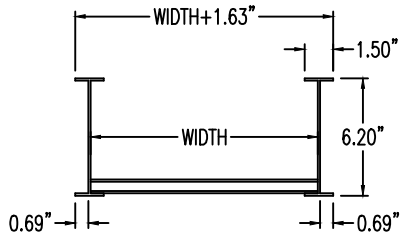

RUNG END VIEWS

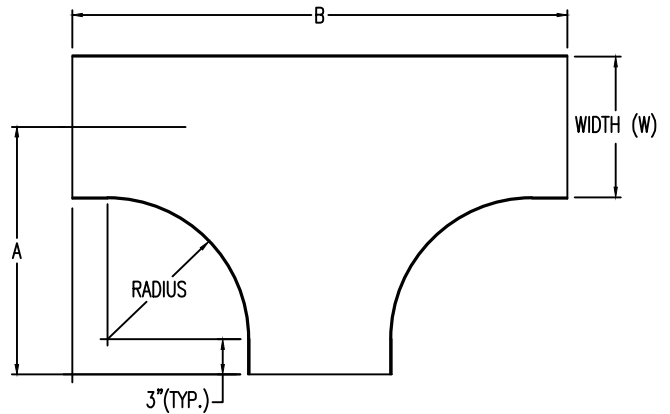
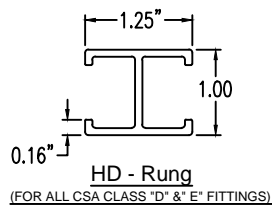
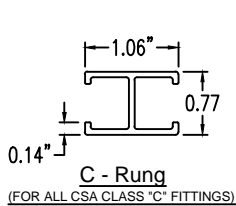

ALUMINUM LADDER/VENTILATED TRAY HORIZONTAL TEE FITTING ORDERING DATA EXAMPLE

L C A 6 3 - (Width) - T - (Radius)

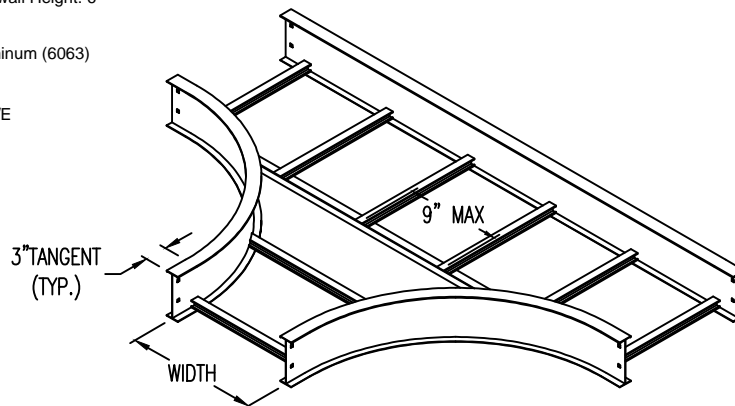
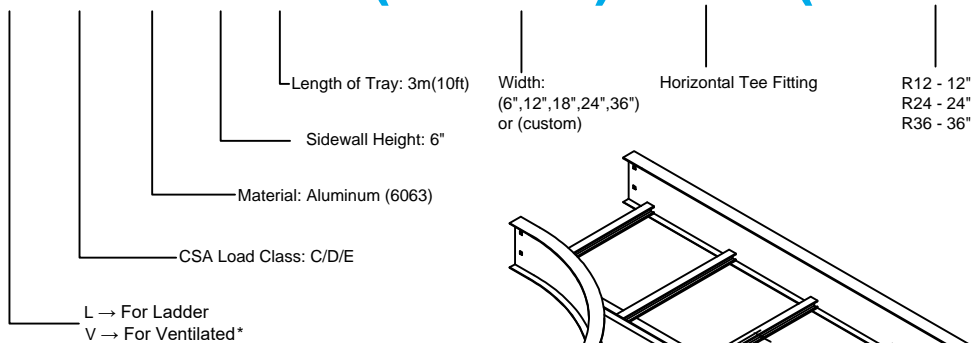

2799 Barton St E
Hamilton, ON L8E 2J8
Toll Free: 1 877.213.8045
Phone: 905.337.7522
Cerinc.ca

NOTES:

* CSA Ventilated tray has a rung spacing of 4" between rungs.

